



More Precision

thermoMETER // Non-contact infrared temperature sensors



Robust miniature pyrometer thermoMETER SE

Temperature measuring range
from -40 to 600 °C

Short response time of 20 ms

Voltage or two-wire current output
(switchable via software)

Open-collector output with 500 mA

No cooling required for ambient
temperatures up to 120 °C

Best price/performance ratio – ideal
for OEM series applications

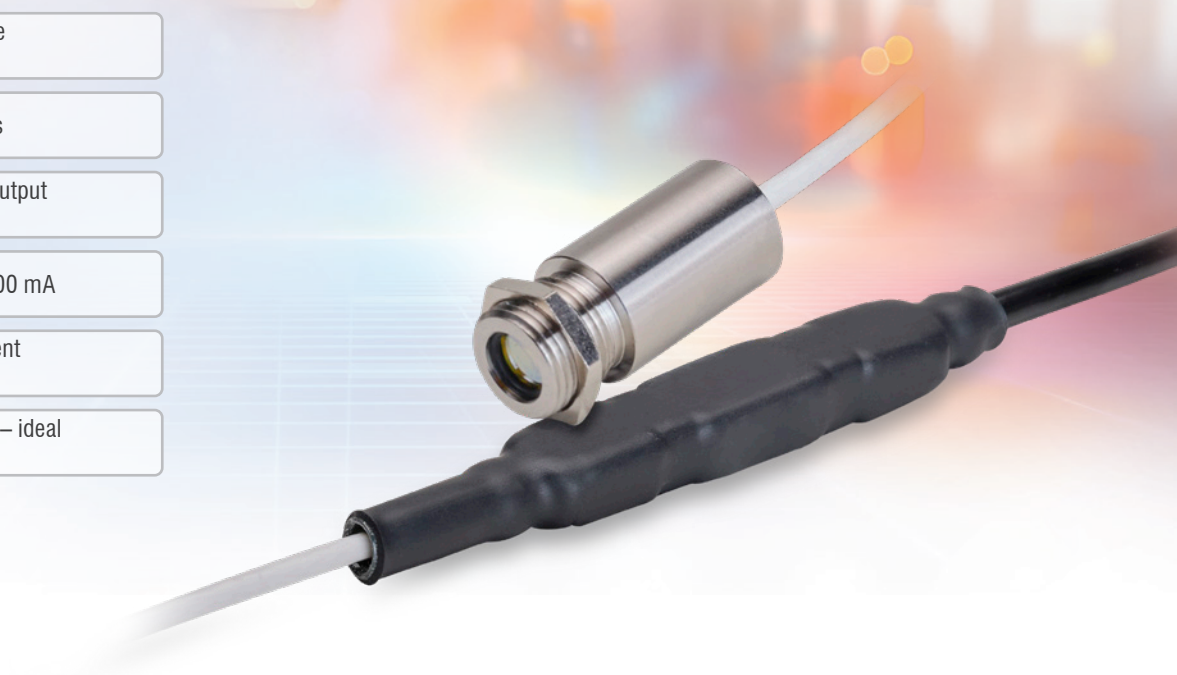

Compact. Robust. Functional.

The thermoMETER SE is a miniature infrared pyrometer for measuring object temperatures up to 600 °C and is ideal for integration into machines and systems (OEM).

The system combines the advantages of the thermoMETER FI with those of the thermoMETER UC. Since the miniature controller is housed in the cable, the space required is minimized. In addition, the detection point and evaluation are locally decoupled so that the sensor delivers precise measurement values even in environments with high temperatures and under harsh conditions.

Ready-made channel

The sensor, controller and connection cable of the thermoMETER SE are already pre-assembled. The connection is direct and quick via the open cable ends. Optionally, the system can be operated via a USB adapter and set using the sensorTOOL software.



Model		SE-SF15	
Optical resolution		15:1	
Measuring range		-40 °C up to 600 °C	
Spectral range		8 to 14 μm	
System accuracy ^[1]		±1.0 % or ±1.0 °C	
Repeatability ^[1]		±0.5 % or ±0.5 °C	
Temperature resolution (NETD) ^[2]		50 mK	
Response time ^[3]		20 ms	
Emissivity		0.100 to 1.100	
Transmittance		0.100 to 1.100	
Signal processing		Intelligent averaging, Min/Max, Hold function with threshold/hysteresis (adjustable via software)	
Supply voltage		5 ... 30 VDC	
Max. current consumption		≤ 4 mA (voltage output) / ≤ 20 mA (2-wire current output)	
Digital interface		3.3V-LVTTL or USB via programming adapter	
Analog output ^[4]		4 ... 20 mA (two-wire current output) / 0 ... 5 V; 0 ... 10 V (voltage output) freely scalable within the measuring range	
Switching output		Open collector for alarm; 500 mA	
Connection		Integrated cable with open ends (ferrules); standard length 0.5 m sensor and connection cable; optional sensor cable with 3 m, 6 m or 15 m and connection cable with 3 m available	
Mounting		Sensor Direct fastening via integrated M12x1 thread or fastening using the hexagon nut included in the scope of delivery	
Temperature range	Sensor	Storage	-40 ... 85 °C
		Operation	-20 ... 120 °C
	Controller	Storage	-40 ... 85 °C
		Operation	-20 ... 80 °C
Humidity		10 % RH ... 95 % RH (non-condensing)	
Shock (DIN EN 60068-2-27)		50g, 11 ms, each axis	
Vibration (DIN EN 60068-2-6)		3g, 11 to 200 Hz, each axis	
Protection class (DIN EN 60529)		Sensor	IP65
		Controller	IP65
Material		Sensor Stainless steel (1.4404)	
Weight		approx. 20 g (sensor only)	
Control and indicator elements ^[5]		Sensor configuration optionally possible via sensorTOOL	

^[1] At ambient temperature of 24 ±2 °C; whichever is greater

^[2] With a time constant of 200 ms and an object temperature of 200 °C

^[3] 0 - 90 % energy; adjustable via software

^[4] Preconfigured for current or voltage on delivery; switchable via sensorTOOL (requires USB converter); voltage scaling depending on the supply voltage

^[5] Access with sensorTOOL requires USB converter (see accessories)

Product identification

SE-	SF15-	S3-	C3-	U
				Output (preconfigured, switchable via software): U: Voltage 0 ... 5 V / 0 ... 10 V I: Current 4 ... 20 mA
				Cable length (controller - open ends): 0.5 m (standard) / 3 m
				Cable length (sensor - controller): 0.5 m (standard) / 3 m / 6 m / 15 m
				Focus: SF15
Series: thermoMETER SE				

Standard Focus (in mm)									
SF15	15:1	6.5	11.5	14	18	23.5	29.5	35.5	
Distance		0	100	200	300	400	500	600	

Close Focus (when using the screwable CF lens, in mm)									
CF15	15:1	6.5	3.7	0.8	4.4	8.1	11.8	15.4	
Distance		0	5	10	15	20	25	30	

 = smallest spot size / focal point (mm)

The ratio D:S (example 15:1, see table) describes the ratio Distance (distance from the front edge of the sensor to the measuring object) to Spot size (measurement spot size).

Technical drawings

thermoMETER

thermoMETER UC

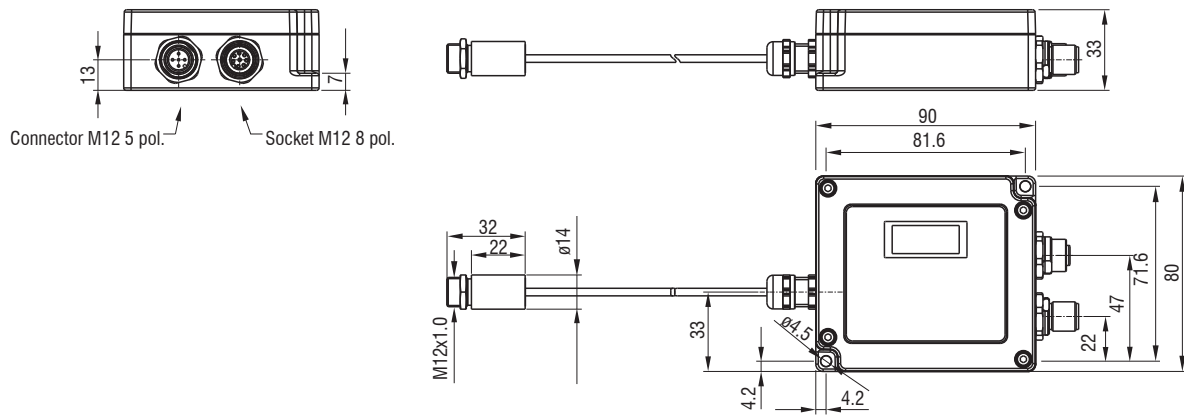

thermoMETER SE



thermoMETER FI

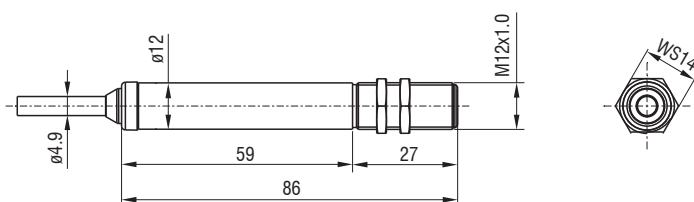





(dimensions in mm, not to scale)

Connection possibilities

thermoMETER





Sensor	Cables	Type
thermoMETER FI	Integrated cable Length 1 m / 3 m / 8 m / 15 m	Open ends (with ferrules)



Connection possibilities and accessories	
Connection supply voltage PS2020	
USB programming adapter for connection to PC TM-USBA USB adapter with terminal block	
Interface module for Ethernet and EtherCAT connection IF1032	
Control / machine Analog output (voltage), open collector	









Sensor	Cables	Type
thermoMETER SE	Sensor cable (sensor controller) Lengths 0.5 m / 3 m / 6 m / 15 m Connection cable (Controller - open ends) Lengths 0.5 m / 3 m	Open ends (with ferrules)



Connection possibilities and accessories	
Connection supply voltage PS2020	
USB programming adapter for connection to PC TM-USBA USB adapter with terminal block	
Interface module for Ethernet and EtherCAT connection IF1032	
Control / machine Analog output (current/voltage), open collector	

Sensor	Cables	Type
thermoMETER UC	Digital cable: TM-DC8/x-M12 Lengths 1 m / 5 m	Open ends (with ferrules)
	Digital cable: TM-USBA-M12 Length 1.8 m	USB
	Analog cable: TM-PC5/x-M12 Lengths 1 m / 5 m	Open ends (with ferrules)



Connection possibilities and accessories	
Connection supply voltage PS2020	
USB programming adapter for connection to PC TM-USBA USB adapter with terminal block	
Control / machine 2x alarm relays, RS485	
Interface module for Industrial Ethernet connection IF2035-PROFINET IF2035-EIP IF2035-EtherCAT	
Connection to PC (sensorTOOL) Display & parameter setting	
Interface module for Ethernet and EtherCAT connection IF1032	
Connection supply voltage PS2020	
Control / machine Analog output (current/voltage)	

Mounting accessories / optical accessories / air purge collars

Art. no.	Name		FI	SE	UC
2970750	TM-DIN-UC	Rail mount adapter	⊗	⊗	✓
2970751	TM-MF-UC	Mounting fork	⊗	✓	✓
2970752	TM-APL	Air purge collar, laminar	✓	✓	✓
2970753	TM-FB	Mounting bracket	✓	✓	✓
2970754	TM-AB-UC	Mounting bracket, adjustable in 2 axes	⊗	✓	✓
2970755	TM-MB-UC	Mounting bolt with M12x1 thread and nut	⊗	✓	✓
2970756	TM-TA	Pipe adapter	✓	✓	✓
2970757	TM-T40	Reflection protection tube, length 40 mm; M12x1 external thread	✓	✓	✓
2970758	TM-T88	Reflection protection tube, length 88 mm; M12x1 external thread	✓	✓	✓
2970759	TM-T20	Reflection protection tube, length 20 mm; M12x1 external thread	✓	✓	✓
2970760	TM-MH-UC	Massive housing made from stainless steel	⊗	✓	✓
2970761	TM-FBMH-UC	Mounting bracket for solid housing	⊗	✓	✓
2970762	TM-APMH-UC	Air purge collar made from stainless steel for solid housing	⊗	✓	✓
2970763	TM-CF	Close Focus lens	✓	✓	✓
2970764	TM-PW	Protective window	✓	✓	✓
2970765	TM-AP-UC	Air purge collar (stainless steel) for lenses from D/S 15:1	⊗	⊗	✓
2970766	TM-AP2-UC	Air purge collar (stainless steel) for lenses with D/S 2:1	⊗	⊗	✓
2970767	TM-AP	Air purge collar	✓	✓	✓
2970768	TM-AP8	Air purge collar with 8 mm hose connection	✓	✓	✓
2970769	TM-MI	Right angle mirror	✓	✓	✓

Connection cables for pyrometer UC

2904051	TM-PC5/1-M12	Analog signal and supply cable 1 m
2904052	TM-PC5/5-M12	Analog signal and supply cable 5 m
2904053	TM-USBA-M12	Digital signal cable with USB converter, 1.8 m, M12 plug, USB-A plug
2904054	TM-DC8/1-M12	Digital signal cable, 1 m, M12 plug, ferrules, pre-assembled
2904055	TM-DC8/5-M12	Digital signal cable, 5 m, M12 plug, ferrules, pre-assembled

USB adapter for pyrometers UC / FI / SE

2970770	TM-USBA	USB adapter with terminal block
---------	---------	---------------------------------

IF2035: Interface module for Industrial Ethernet connection

- Connection of RS422 or RS485 interfaces to PROFINET / Ethernet/IP / EtherCAT
- Synchronization output for RS422 sensors
- 2 network connections for different network topologies
- Data rate up to 4 MBaud
- 4-fold oversampling (with EtherCAT)
- Ideal for confined spaces due to a compact housing and DIN rail mounting

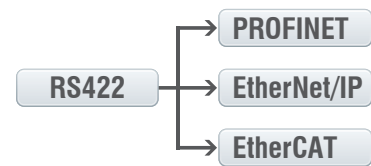

IF1032: Interface module for Ethernet & EtherCAT connection

- Connection of analog output or RS485 to Ethernet and EtherCAT
- Web interface for data display and scaling
- CSV export



Sensors and Systems from Micro-Epsilon



Sensors and systems for displacement, distance and position



Sensors and measurement devices for non-contact temperature measurement

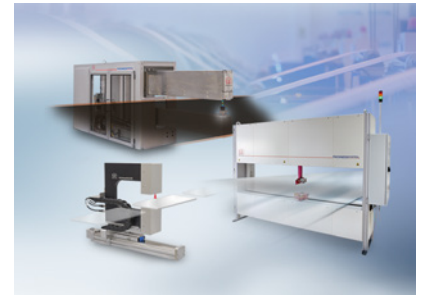

Measuring and inspection systems for metal strips, plastics and rubber



Optical micrometers and fiber optics, measuring and test amplifiers



Color recognition sensors, LED analyzers and inline color spectrometers

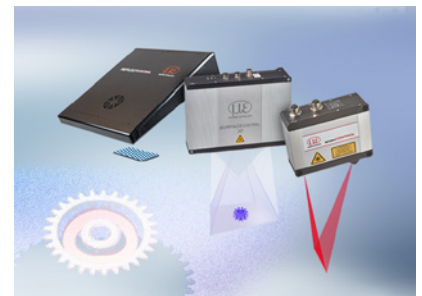

3D measurement technology for dimensional testing and surface inspection