



More Precision

interferoMETER // High precision absolute interferometers



High-precision absolute interferometers interferoMETER

The innovative Micro-Epsilon interferometers for absolute measurements set a benchmark in high-precision distance and thickness measurements. These sensors enable stable measurement results with sub-nanometer resolution, offering a comparatively large measuring range and offset distance.

Interferometers from Micro-Epsilon work differently than laser interferometers with polychromatic white light. Their integrated light source uses an extended wavelength spectrum instead of a defined wavelength. This means that significantly more information is available for evaluating the superposition of received wavelengths.

This results in advantages for the measurement:

- Absolute measurements with highest precision, even with moving targets
- Wide range of applications: distance measurement, multi-peak measurement of several layers and thickness measurement of thin layers as well
- Maximum signal stability for industry, machine building or laboratory as well as in the semiconductor sector and vacuum

Maximum signal stability for nanometer precision

Micro-Epsilon interferometers generate precise and stable measurement values. This allows precise process control.

Easy controller replacement

IMS5400 controllers are easily replaceable - no sensor dismantling or recalibration required.



Distance-independent thickness measurements

The IMS5400-TH systems provide thickness values of individual layers up to 2.1 mm total thickness. The target can move freely in the operating range.





Unmatched precision

The IMS5400-DS and IMS5600-DS systems are used for absolute distance measurements. They provide highly precise measurement values which brings advantages for distance control and for profile measurements of moving objects.

Overview

interferoMETER

General information	Page
Unmatched precision for industrial series applications	4 - 6
Possible applications - the right system for every application	7
Application examples	8 - 9

System type		Purpose	Resolution	Page
interferoMETER IMS5400-DS	For absolute distance measurement with nanometer resolution	Distance  Multi-peak / layer thickness	< 1 nm	10 - 11 14 - 15
interferoMETER IMS5600-DS	For absolute distance measurement with subnanometer resolution	Distance  Multi-peak / layer thickness	< 30 pm	12 - 15
interferoMETER IMS5400-TH	For stable thickness measurement with nanometer resolution	Thickness  Multi-peak	< 1 nm	16 - 19
interferoMETER IMS5420-TH	For stable wafer thickness measurement in inline processes	Thickness  Multi-peak	< 1 nm	20 - 23

Connection options / Accessories	Page
Connection possibilities	24 - 25
Optional accessories	26 - 27

Absolute measurements for unmatched precision

The advantages of absolute measurement

While Micro-Epsilon white light interferometers provide absolute measurement values, common laser interferometers are based on the principle of relative measurements. The IMS white light interferometers provide stable and absolute measurements without prior referencing. This is particularly favorable in the event of signal interruptions caused by steps, holes, false reflections or structured surfaces, for example. After the signal interruption, you directly receive a measurement value, whereas laser interferometers must first be re-referenced. Thus, distance profiles of moving measuring objects can be reliably generated with high precision.

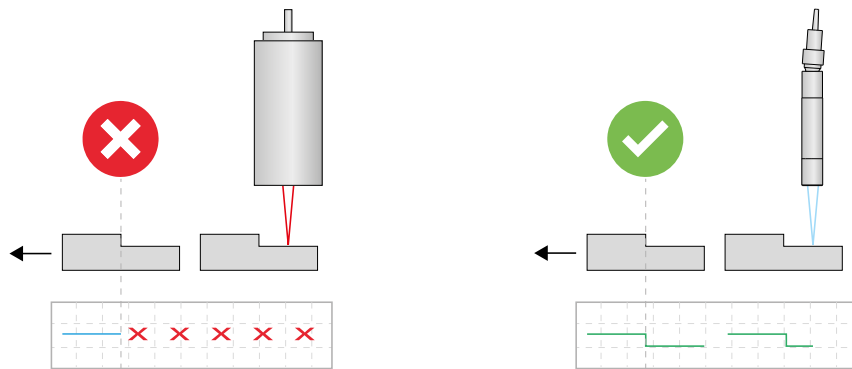

Conventional laser interferometer
Reference required, loses position after signal interruption

White light interferometer
No reference, absolute measurement value before and after a signal interruption

Measurement modes

DS

Distance measurement

TH

Thickness measurement

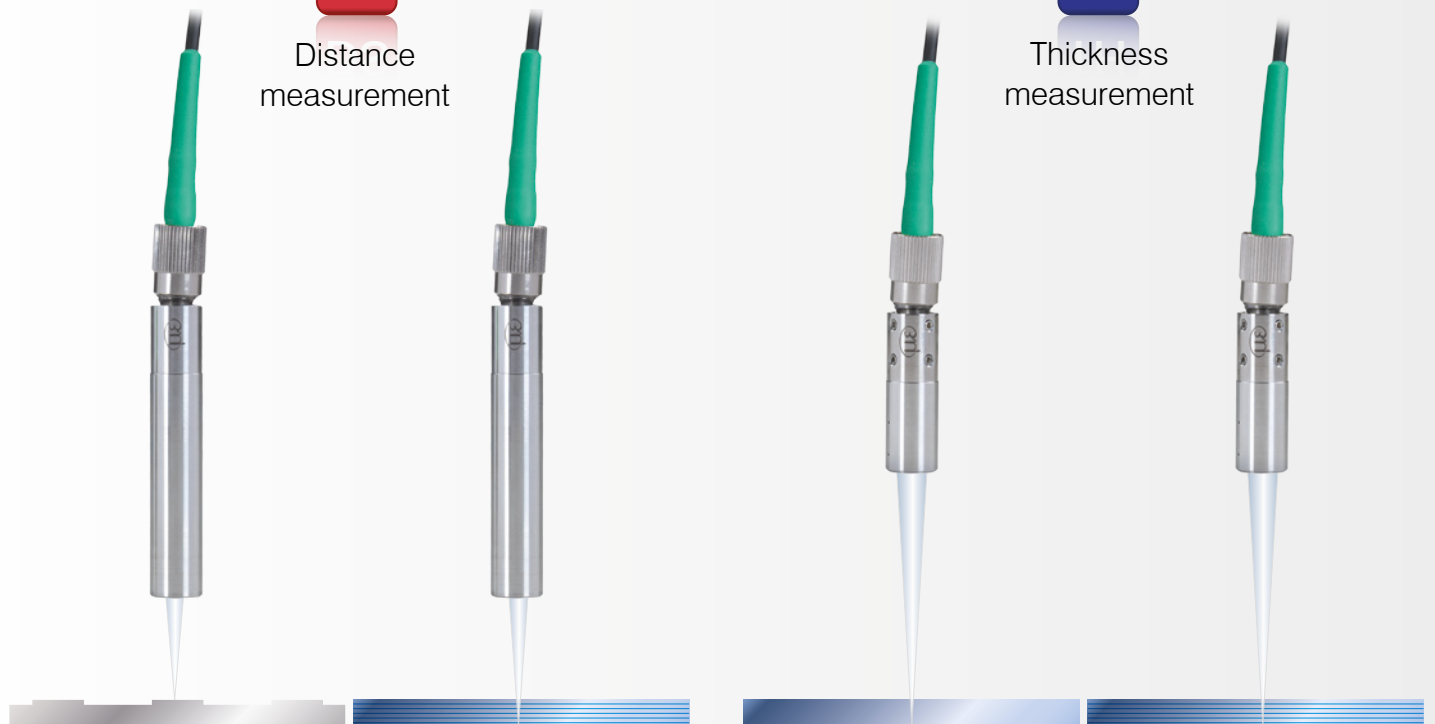

Distance

- Absolute distance measurement without referencing
- Measurement of steps without signal fail

Multi-peak distance

- Up to 14 distance values on transparent objects
- Calculation and output of thickness values

High-precision thickness

- High-precision thickness measurement of transparent materials, even with moving objects
- Output of the thickness values

Multi-layer thickness

- Multi-peak thickness measurement (MP) of up to 5 layers
- Output of the thickness values

Precise and stable down to the last nanometer

- Greatest possible precision with large offset distance and measuring range
- Small light spot for detecting small details, e.g. structures on semiconductors and miniature electronic components.
- Vacuum-compatible sensors, ideal for the semiconductor industry

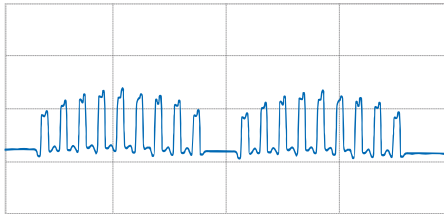

Structured wafer profile

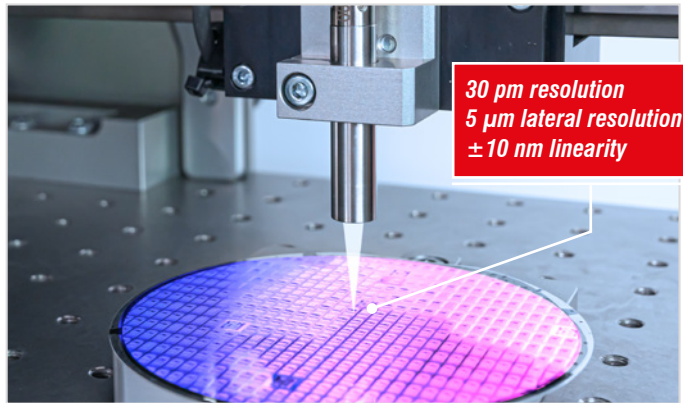

The IMS5600-DS offers highest precision in distance measurements. The absolute measurement allows for profiles of moving objects to be detected as well.

Fast measurements on many surfaces



Glass



Metal



Films / coatings



Lenses

User-friendly web interface for easy operation

The entire configuration is performed without additional software via an intuitive web interface. The web interface is accessed via an Ethernet connection and enables simple setting of averaging, measuring rate or presets, for example. An editable material table is available for thickness measurement.

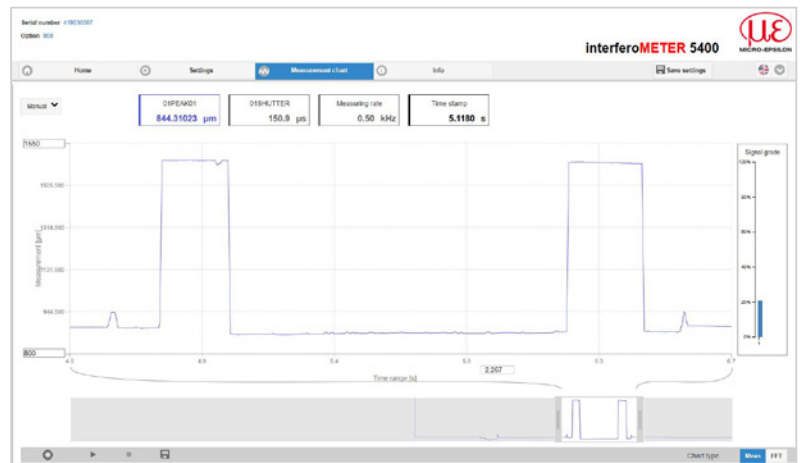

Measurement chart

gap and distance

gap and thickness

Presets for easy operation

Material	Group index	Description	Unit
Vacuum	1.000000	Perfect vacuum	✓
Air	1.000274	845nm, 20C, laboratory conditions, Oudin et al. 1996	✓
Ethanol	1.366600	845nm, 20C, Kadenburg et al. 2012	✓
PMMA	1.496000	Poly(methyl methacrylate), 845nm, 23C, Sozhanov et al. 2013	✓
PS	1.604000	Polystyrene, 20C, Sultanow et al. 2009	✓
PC	1.587700	Polycarbonate, 845nm, 20C, Sultanow et al. 2009	✓
Fused Silica	1.465800	Fused quartz, 845nm, 20C, Melhorn et al. 1995	✓
SiO ₂	1.529000	SiO ₂ , 845 nm, 20C, SCHOFF	✓

Materials table for thickness measurements

Unmatched precision for industrial series applications



Due to their robust design, the interferometers are also used in industrial environments, for example for high-precision thickness monitoring of plastic films.

Patented pilot laser for exact visualization of the measuring point

- Visualization of the measuring position with a patented pilot laser
- In addition to the measuring position, the pilot laser also provides feedback on the distance:
Measuring object in the measuring range: constant illumination of the pilot laser
Measuring object outside the measuring range: pilot laser flashes.

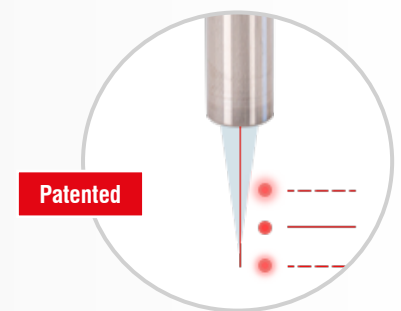

Wide range of applications

- Robust and compact sensors for industrial measurement tasks
- UHV sensors for use in the semiconductor industry
- Controller equipment:
 - Metal housing
 - DIN rails (enables easy installation in control cabinets)
- Active temperature compensation and passive cooling provide very stable measurement results

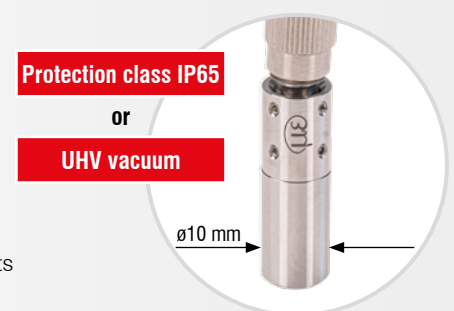

Simple integration on site

- Interchangeability of components enables flexible integration
- Fast and efficient on-site service
- Light source replacement possible by Micro-Epsilon service staff on the production line
- Sensor replacement of the same type (for IMS5400):
sensor removal or recalibration at the Micro-Epsilon factory is not necessary
- Length variation and replacement of cables of the same type are possible by the customer:
not necessary to send in the system.

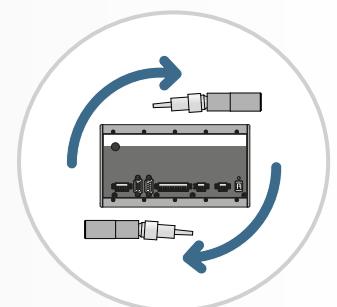

The right system for every application

The interferoMETER controllers can be combined with numerous sensors. The sensor and controller are matched and calibrated at the factory. This enables nanometer-precise positioning tasks, distance measurements and layer thickness measurements, including in clean room environments and vacuum.

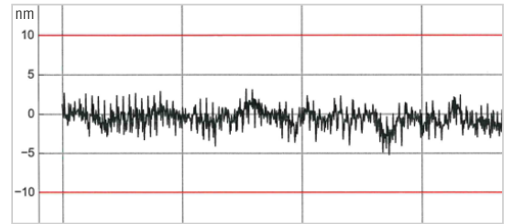

The interferoMETERS are supplied with individual calibration reports documenting the precision achieved.



interferoMETER 5400-DS

- Absolute interferometer for distance measurements with nanometer resolution
- Compact and robust sensors: sensors with radial or axial beam path, vacuum-compatible sensors
- Multi-peak distance measurement with 14 distance values and thickness calculation



interferoMETER 5600-DS

- Absolute interferometer for distance measurements with subnanometer resolution
- Compact and robust sensors: sensors with radial or axial beam path, vacuum-compatible sensors
- Multi-peak distance measurement with 14 distance values and thickness calculation



interferoMETER 5400-TH

- Absolute interferometer for thickness measurement with submicrometer accuracy
- Compact and robust sensors, also for vacuum applications
- Multi-peak thickness measurement for up to 5 layers



interferoMETER 5420

- Absolute interferometer for thickness measurement of doped and undoped wafers
- Multi-peak thickness measurement for up to 5 layers
- Protection class IP67 possible
- Compact and robust sensors

Analog

RS422

Ethernet

EtherCAT[®]
Technology Group

PROFI
NET[®]

EtherNet/IP[®]

Applications

interferoMETER

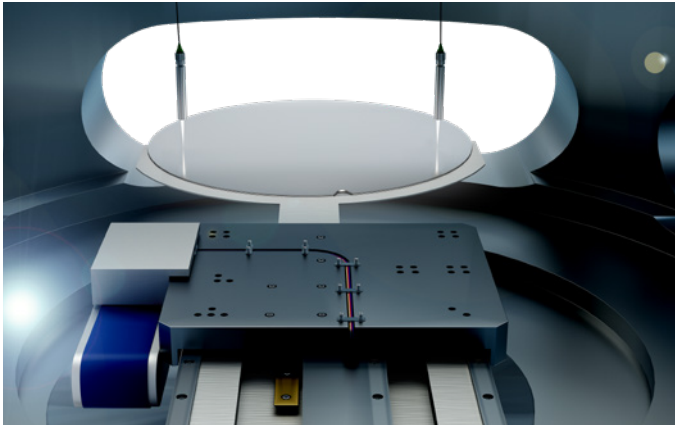

Wafer tilt measurement

Absolute interferometers are used to measure the tilt angle of wafers during the infeed. The interferometers provide absolute distance values at subnanometer resolution. The measurement ensures the greatest possible positional accuracy when wafers are picked up and removed.

Sensor: *interferoMETER IMS5600-DS19/VAC*

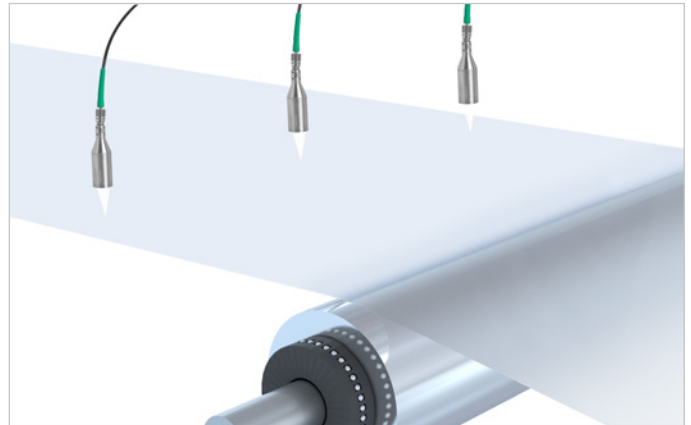

Thickness measurement of plastic films

IMS5400-TH absolute interferometers are used for inline thickness monitoring of films. The thickness values are detected with submicrometer accuracy at a high measuring rate, even if the film vibrates.

Sensor: *interferoMETER IMS5400-TH70*

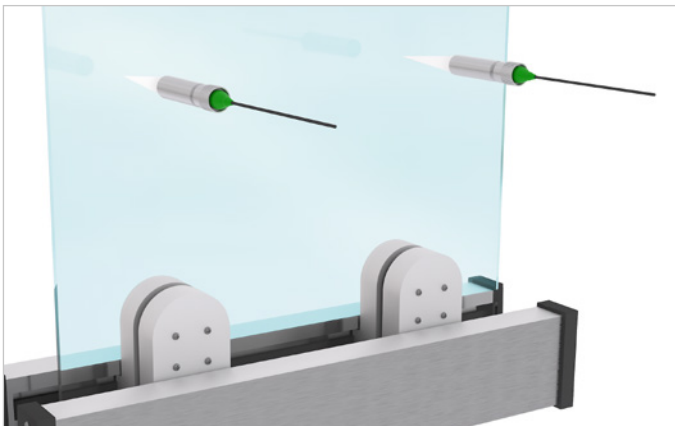

Position measurement when fitting precision glass

In addition to single-peak distance measurements, the absolute interferometers are also used for multi-peak distance measurements. This means that both distance values and calculated thickness values can be used to control positioning tasks with maximum precision.

Sensor: *interferoMETER IMS5400MP-DS19*



Multi-layer thickness measurement of display glass

The IMS5400-TH absolute interferometers impress with their high measurement stability for inline thickness measurement of display glass. With the multi-peak thickness measurement, up to 5 layers or air gaps can be measured simultaneously.

Sensor: *interferoMETER IMS5400MP-TH45*

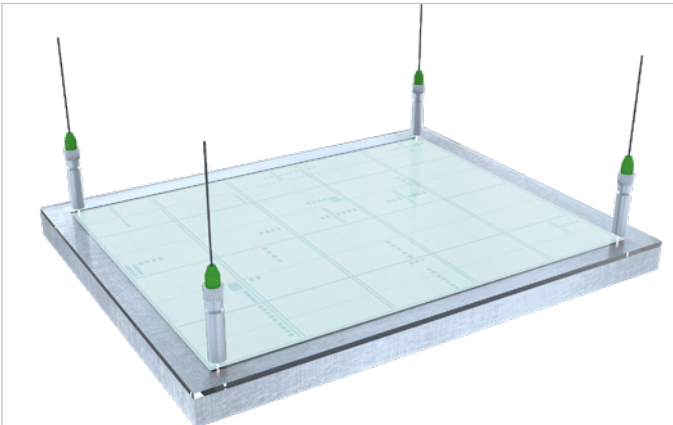

Checking the mask position

Absolute interferometers are used to align photomasks. The interferometers provide absolute measurement values in the subnanometer range and enable high-precision positioning of the mask. They can also be used in a vacuum.

Sensor: *interferoMETER IMS5600MP-DS19/VAC*

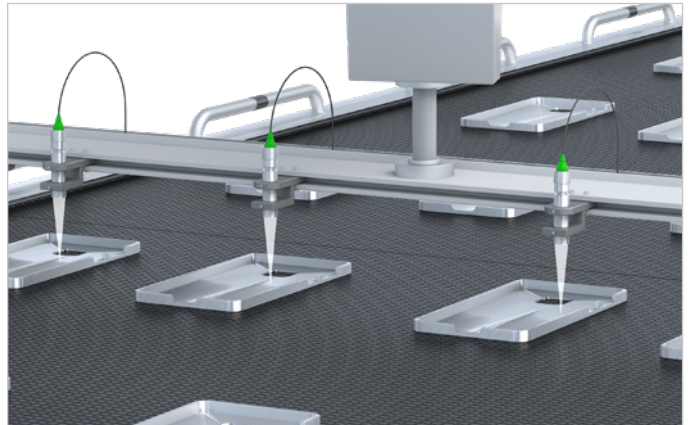

High-precision thickness measurement of transparent layers

IMS5400-TH absolute interferometers are used to test the thickness of coatings. Thanks to the large working range, no exact z-positioning is required. The thickness values are detected with micrometer accuracy at a high measuring rate.

Sensor: *interferoMETER IMS5400MP-TH45*

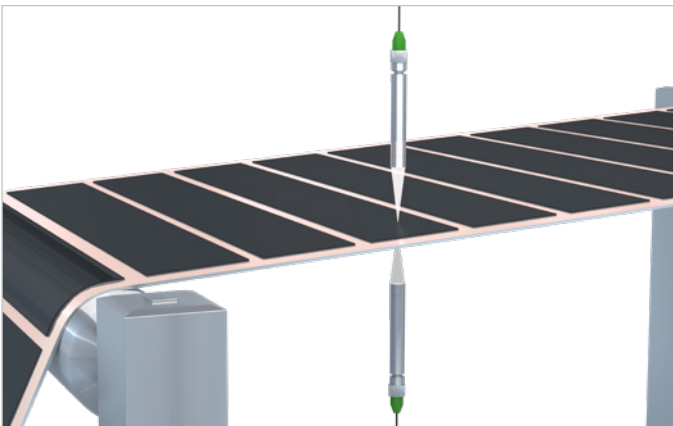

Thickness measurement of electrode coatings

Two absolute interferometers arranged opposite each other measure the thickness of coated electrodes using the differential thickness method. At a constant distance from each other, the two sensors each detect the distance to the film. The absolute interferometers enable a measurement resolution in the nanometer range. The thickness values are used to control the application of the coating and for quality assurance purposes.

Sensor: *interferoMETER IMS5400-DS19*

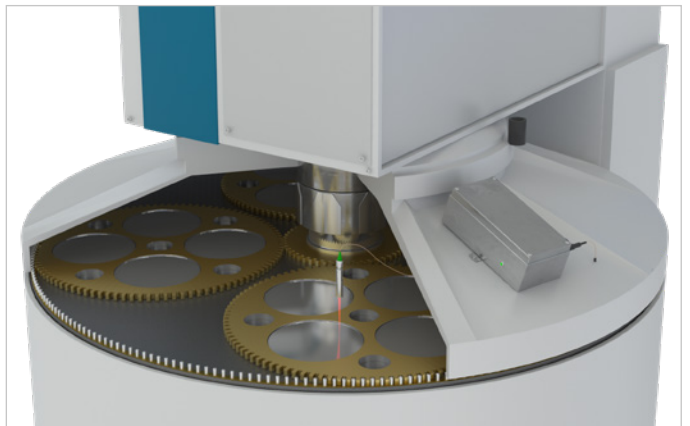







Precise thickness measurement during lapping

In wafer fabrication, a crystalline silicon ingot is cut into thin slices of about 1 mm. The discs are then ground and lapped to obtain the desired thickness and surface finish. To achieve high process stability, *interferoMETERs* are used for inline thickness measurement in lapping and grinding machines. Due to its compact design, the sensor can also be integrated in confined installation spaces. The thickness values are used for machine control as well as for quality control of the wafer.

Sensor: *interferoMETER IMS5420-TH24*

Absolute distance measurements with nanometer resolution

interferoMETER 5400-DS

-  Absolute measurement with nanometer resolution
-  Compact and robust sensors with large offset distance
-  Measuring rate up to 6 kHz for high speed measurements
-  Ethernet / EtherCAT / RS422 / PROFINET / EtherNet/IP
-  Robust controller with passive cooling
-  Easy configuration via web interface
-  Flexible industrial integration



Absolute distance measurements with nanometer resolution

The IMS5400-DS absolute interferometer opens up new perspectives in industrial distance measurements. The controller has an intelligent evaluation feature and enables absolute measurements with nanometer resolution at a relatively large offset distance. Compared to other absolute measuring optical systems, the IMS5400-DS offers an unsurpassed combination of accuracy, measuring range and offset distance.

Small light spot for the smallest of details and structures

The sensors generate a small light spot over the entire measuring range.

The light spot diameter is only $10\ \mu\text{m}$ in the mid of the measuring range and enables the detection of small details, for example structures on semiconductors and miniature electronic components.

Absolute measurement of step profiles

Unlike interferometers based on relative measurements, the IMS5400-DS also enables the measurement of step profiles. Thanks to the absolute measurement, the scanning is performed with high signal stability and precision. When measuring on moving objects, the differences in height of heels, steps and depressions can thus be reliably detected.

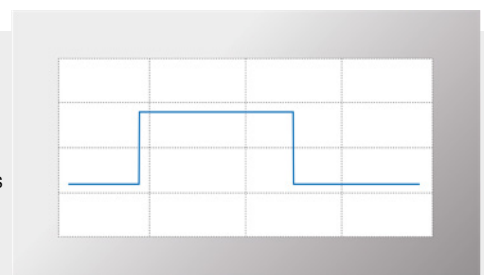
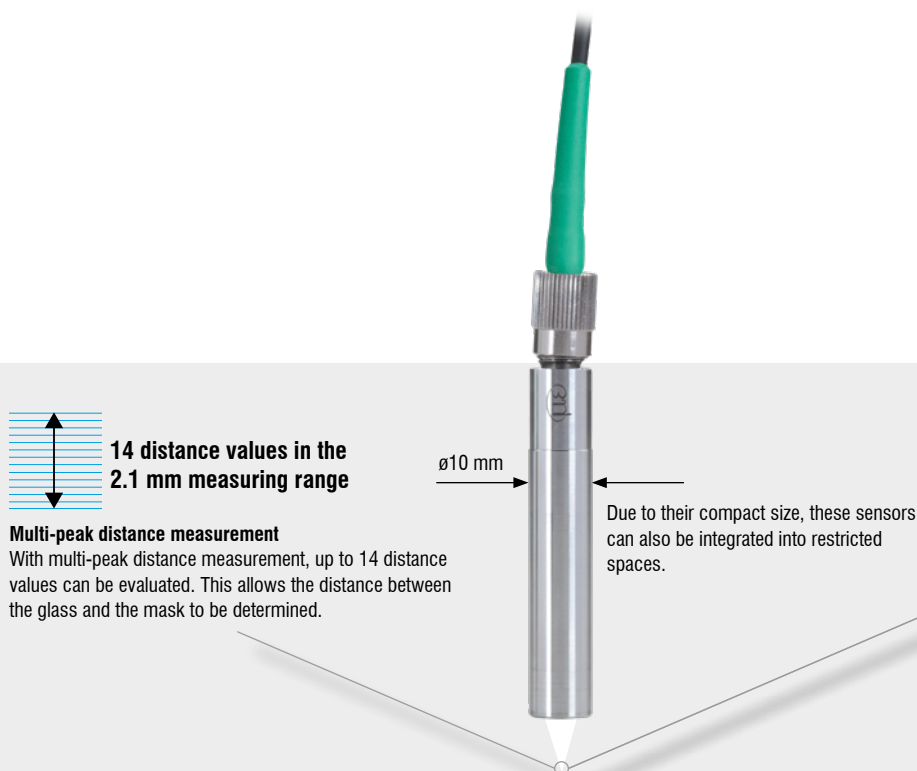

Absolute measurement of step profiles

Due to the absolute thickness measurement, step profiles are detected with high signal stability and subnanometer resolution.

Controller

Model	IMS5400-DS	IMS5400MP-DS
Resolution ^[1]	< 1 nm	
Measuring rate	continuously adjustable from 100 Hz to 6 kHz	
Linearity ^[2]	< ±50 nm	< ±50 nm for the first distance; < ±150 nm for each further distance
Temperature stability	temperature compensated, stability < 10 ppm between +15 ... +35 °C	
Multi-peak measurement	-	up to 13 layers
Light source	NIR-SLED, narrow wavelength band at approx. 840 nm; pilot laser: laser LED, wavelength 635 nm	
Laser class	Class 1 according to DIN EN 60825-1: 2015-07; Pilot laser: Class 1, power (< 0.2 mW)	
Supply voltage	24 VDC ±15 %	
Power consumption	approx. 10 W (24 V)	
Signal input	Sync in, trigger in, 2x encoders (A+, A-, B+, B-, index)	
Digital interface	Ethernet / EtherCAT / RS422 / PROFINET ^[3] / EtherNet/IP ^[5]	
Analog output	4 ... 20 mA / 0 ... 10 V (16 bit D/A converter)	
Switching output	Error1-Out, Error2-Out	
Digital output	sync out	
Connection	Optical	Pluggable fiber optic cable via E2000 socket (controller); see accessories for cable lengths; bending radius: static 30 mm, dynamic 40 mm
	Electrical	3-pin supply terminal strip; encoder connection (15-pin, HD-sub socket, max. cable length 3 m, 30 m with external encoder supply); RS422 connection socket (9-pin, Sub-D, max. cable length 30 m); 3-pin output terminal strip (max. cable length 30 m); 11-pin I/O terminal strip (max. cable length 30 m); RJ45 socket for Ethernet (out) / EtherCAT (in/out) (max. cable length 100 m)
Mounting	Free-standing, DIN rail mounting	
Temperature range	Storage	-20 ... +70 °C
	Operation	+15 ... +35 °C
Shock (DIN EN 60068-2-27)	15 g / 6 ms in XY axis, 1000 shocks each	
Vibration (DIN EN 60068-2-6)	2 g / 20 ... 500 Hz in XY axis, 10 cycles each	
Protection class (DIN EN 60529)	IP40	
Material	Aluminum housing, passive cooling	
Control and indicator elements	Multifunction button: two adjustable functions and reset to factory settings after 10 s; web interface for setup: selectable presets, freely selectable averaging, data reduction, setup management; 6 x color LEDs for intensity, range, SLED, pilot laser, status and power; pilot laser: can be switched on for sensor alignment	







^[1] All data at constant ambient temperature (24 ±2 °C). Measuring rate 0.5 kHz, moving average over 64 values, measured differentially between the front and back of a thin glass plate in the mid of the measuring range (2 sigma)

^[2] Maximum deviation from reference system over the entire measuring range, measured on front surface of ND filter

^[3] Optional connection via interface module (see accessories)

Absolute distance measurements with subnanometer resolution

interferoMETER 5600

-  Distance measurement with subnanometer precision
-  Best-in-Class: Resolution < 30 picometers
-  Absolute measurement, suitable for step profiles
-  Compact and robust sensors with large offset distance
-  Measuring rate up to 6 kHz for high speed measurements
-  Ethernet / EtherCAT / RS422 / PROFINET / EtherNet/IP
-  Flexible industrial integration

DS



Designed for high-resolution distance measurements in clean rooms & vacuums

The IMS5600-DS absolute interferometer is used for distance measurements with maximum precision. The controller offers a special calibration with intelligent evaluation and enables absolute measurements with subnanometer resolution. This includes measurement tasks with the highest accuracy requirements, for example in electronics and semiconductor production. For vacuum applications, Micro-Epsilon offers special sensors, cables and feedthrough accessories. These sensors and cables are particle-free to a high degree and can even be used in UHV.

Absolute distance measurements with a large measuring range and offset distance

The IMS5600-DS system is used for high-precision displacement and distance measurements. The system provides absolute measurement values and can therefore also be used for distance measurement of step profiles. Thanks to the absolute measurement, sampling is performed without signal loss. When measuring on moving objects, the differences in height of heels, steps and depressions can thus be reliably detected. The measuring system offers sub-nanometer resolution with a large offset distance in relation to the measuring range.

Multi-peak distance measurement

With multi-peak distance measurements on transparent objects, up to 14 distance values can be evaluated. For example, the distance between the glass and the mask can be determined. If required, the controller can calculate the glass thickness based on the peaks.

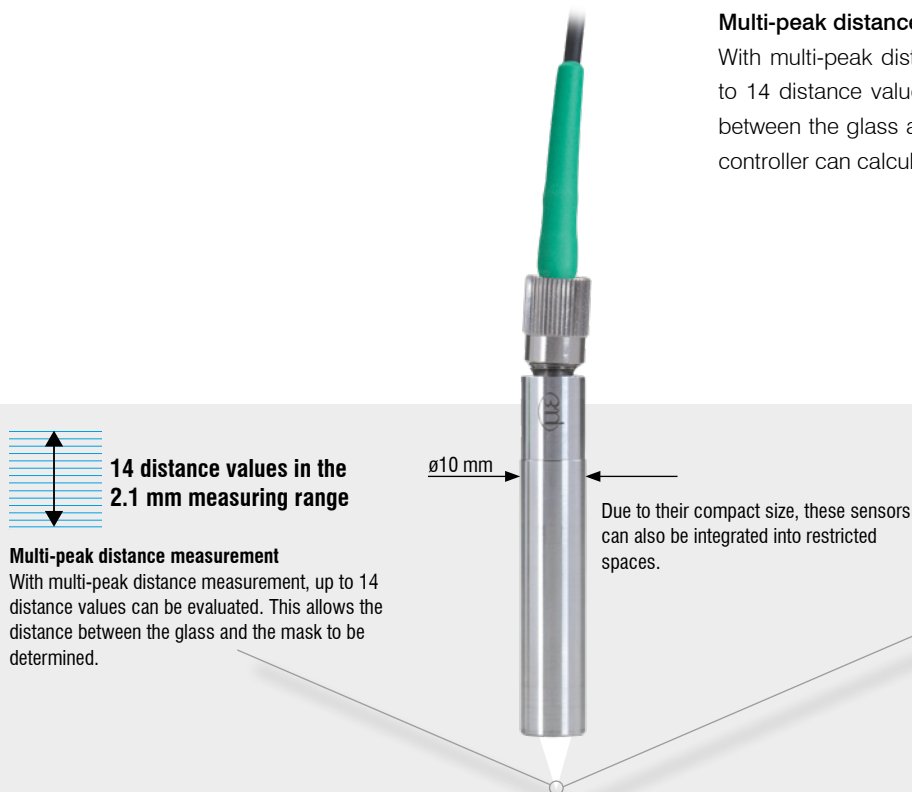

14 distance values in the 2.1 mm measuring range

Multi-peak distance measurement

With multi-peak distance measurement, up to 14 distance values can be evaluated. This allows the distance between the glass and the mask to be determined.

Due to their compact size, these sensors can also be integrated into restricted spaces.

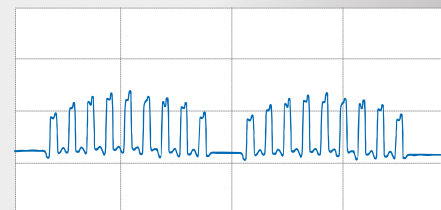

Absolute measurement of step profiles

Due to the absolute thickness measurement, step profiles are detected with high signal stability and subnanometer resolution.

Controller

Model	IMS5600-DS	IMS5600MP-DS
Resolution ^[1]	< 30 pm	
Measuring rate	continuously adjustable from 100 Hz to 6 kHz	
Linearity ^[2]	< ±10 nm	< ±10 nm for the first distance; < ±100 nm for each further distance
Temperature stability	temperature compensated, stability < 10 ppm between +15 ... +35°C	
Multi-peak measurement	-	up to 13 layers
Light source	NIR-SLED, narrow wavelength band at approx. 840 nm; pilot laser: laser LED, wavelength 635 nm	
Laser class	Class 1 according to DIN EN 60825-1: 2015-07; Pilot laser: Class 1, power (< 0.2 mW)	
Supply voltage	24 VDC ±15 %	
Power consumption	approx. 10 W (24 V)	
Signal input	Sync in, trigger in, 2x encoders (A+, A-, B+, B-, index)	
Digital interface	Ethernet / EtherCAT / RS422 / PROFINET / EtherNet/IP ^[3] / EtherNet/IP ^[3]	
Analog output	4 ... 20 mA / 0 ... 10 V (16 bit D/A converter)	
Switching output	Error1-Out, Error2-Out	
Digital output	sync out	
Connection	Optical	Pluggable fiber optic cable via E2000 socket (controller); see accessories for cable lengths; bending radius: static 30 mm, dynamic 40 mm
	Electrical	3-pin supply terminal strip; encoder connection (15-pin, HD-sub socket, max. cable length 3 m, 30 m with external encoder supply); RS422 connection socket (9-pin, Sub-D, max. cable length 30 m); 3-pin output terminal strip (max. cable length 30 m); 11-pin I/O terminal strip (max. cable length 30 m); RJ45 socket for Ethernet (out) / EtherCAT (in/out) (max. cable length 100 m)
Mounting	Sensor via radial clamping or mounting adapter (see accessories); controller free-standing or top-hat rail mounting	
Temperature range	Storage	-20 ... +70 °C
	Operation	+15 ... +35 °C
Shock (DIN EN 60068-2-27)	15 g / 6 ms in XY axis, 1000 shocks each	
Vibration (DIN EN 60068-2-6)	2 g / 20 ... 500 Hz in XY axis, 10 cycles each	
Protection class (DIN EN 60529)	IP40	
Material	Aluminum housing, passive cooling	
Control and indicator elements	Multifunction button: two adjustable functions and reset to factory settings after 10 s; web interface for setup: selectable presets, freely selectable averaging, data reduction, setup management; 6 x color LEDs for intensity, range, SLED, pilot laser, status and power; pilot laser: can be switched on for sensor alignment	

^[1] All data at constant ambient temperature (24 ±2 °C). Measuring rate 0.5 kHz, moving average over 64 values, measured differentially between the front and back of a thin glass plate in the mid of the measuring range (2 sigma)

^[2] Maximum deviation from reference system over the entire measuring range, measured on front surface of ND filter

^[3] Optional connection via interface module (see accessories)

Sensors for distance measurements

interfero**METER** 5400-DS/5600-DS



Sensors for the IMS5400 / IMS5600 controllers for distance measurement

Model		IMP DS1/VAC	IMP DS0.5/90/VAC	IMP DS10/90/VAC	IMP DS19
Measuring range	Distance	1 mm	1.5 mm	1.5 mm	2.1 mm
	Thickness ^[1]	0.01 ... 0.7 mm	0.01 ... 1.0 mm	0.01 ... 1.0 mm	0.01 ... 1.3 mm
Start of measuring range		1 mm	0.5 mm	10 mm	19 mm
Temperature stability		Linearity: typ. 0.1 nm / K (without offset shift)			
Light spot diameter ^[2]		10 μm			
Measuring angle ^[3]		±2°			
Target material		Glass, reflecting or diffuse surfaces ^[4]			
Connection	Optical	Sensor with integrated vacuum optical fiber; length 2 m and FC/APC connector. Extension via pluggable optical fiber FC socket (vacuum feedthrough); cable lengths see accessories; bending radius: static 30 mm, dynamic 40 mm	Pluggable fiber optic cable via FC socket (vacuum feedthrough); pluggable UHV fiber optic cable via FC socket (feedthrough and sensor with vacuum capability); cable lengths see accessories; bending radius: static 30 mm, dynamic 40 mm		
Mounting		Radial clamping, mounting adapter (see accessories)			
Temperature range	Storage	-20 ... +70 °C			
	Operation	+5 ... +70 °C			
Dimensions	Diameter	Ø4	Ø10	Ø10	Ø10
	Length	23 mm	approx. 78.1 mm	approx. 68.6 mm	55 mm
Protection class (DIN EN 60529)		IP40	IP40	IP40	IP65; IP40 (option/VAC)
Vacuum		UHV (cable and sensor)	UHV (cable and sensor)	UHV (cable and sensor)	Optional UHV (cable and sensor)
Material		Stainless steel; optional: titanium housing	Stainless steel	Stainless steel; optional: titanium housing	Stainless steel; optional: titanium housing

^[1] Application for MP measurement

^[2] All data at constant ambient temperature (24 ±2 °C). In the mid of the measuring range

^[3] Maximum sensor tilt angle that produces a usable signal on polished glass (n = 1.5) in the mid of the measuring range. The accuracy decreases when approaching the limit values.

^[4] Non-transparent materials require optically dense surface at a wavelength of 840 nm

Dimensions

IMS5400-DS / IMS5600-DS controller

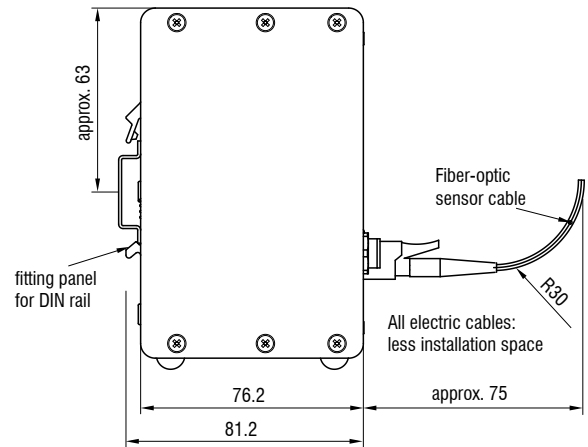
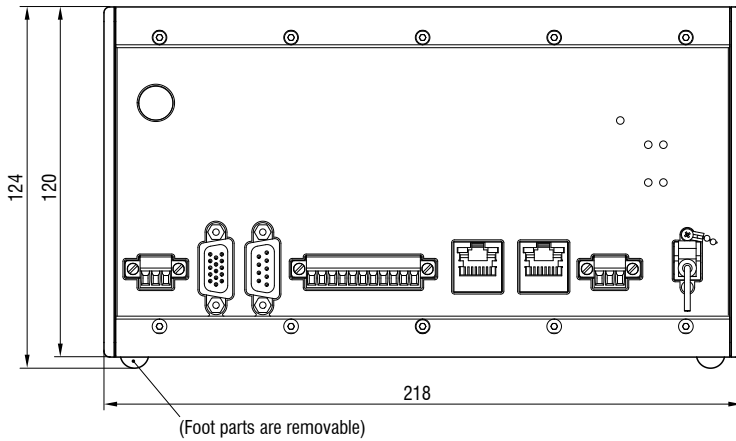

Distance sensor IMP DS0.5/90/VAC

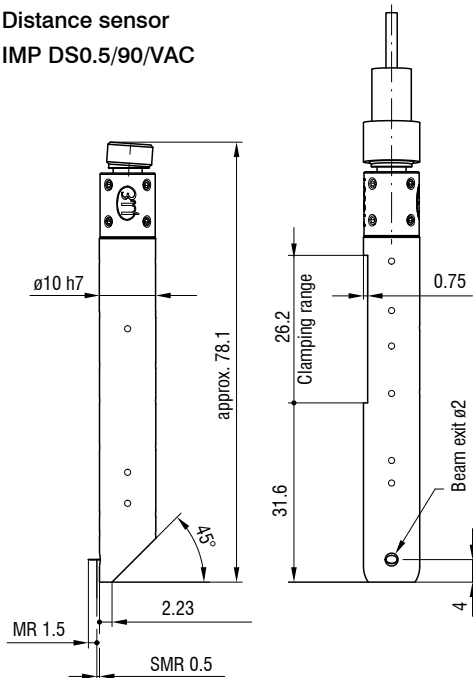

Distance sensor IMP DS1/VAC

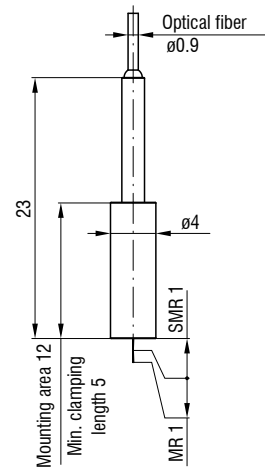

Distance sensor IMP DS10/90/VAC

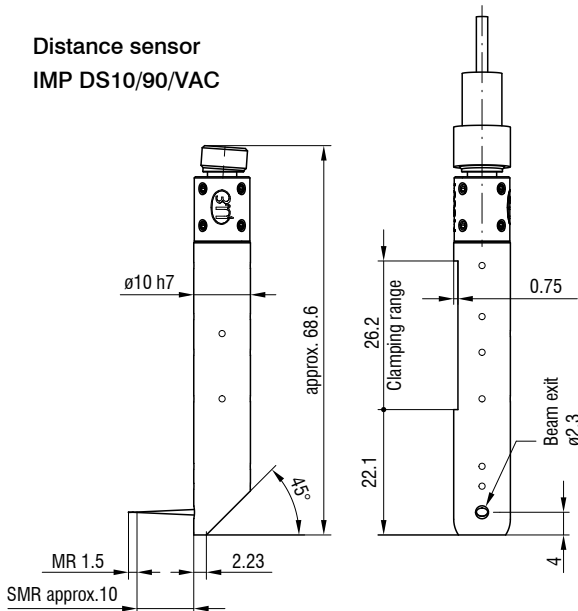



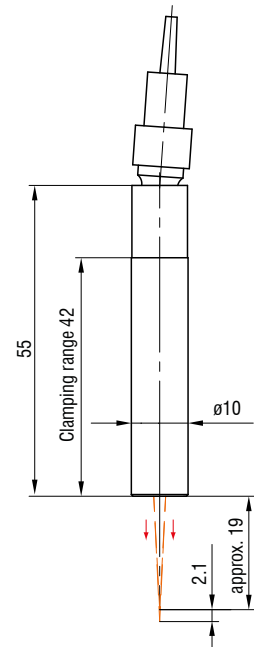



Distance sensor IMP-DS19



Stable thickness measurement with submicrometer resolution

interferoMETER 5400-TH

-  Nanometer-accurate thickness measurement, even with varying distances
-  Stable measurement from a long distance
-  Precise thickness measurement of up to 5 layers
-  Measuring rate up to 6 kHz for high speed measurements
-  **INTERFACE** Ethernet / EtherCAT / RS422 / PROFINET / EtherNet/IP
-  Flexible industrial integration



Stable thickness measurement with varying distances

The IMS5400-TH absolute interferometer opens up new perspectives in industrial thickness measurements. The interferometer is used for highly accurate thickness measurements from a relatively large distance. The large thickness measuring range allows the measurement of thin layers, flat glass and films. As the absolute interferometer works with an SLED in the near-infrared range, it is possible to measure the thickness of optically non-dense objects such as anti-reflective coated glass.

Reliable even with vibrating materials

A decisive advantage is the distance-independent measurement, where a stable nanometer-accurate thickness value is achieved. This is how the target can move within the measuring range without influencing the accuracy.

With the multi-layer thickness measurement (IMS5400.../MP) up to 5 layers can be measured

The measuring range for air gap measurement (with refractive index ~1) is 50 μm to 2.1 mm and for glass thickness measurement (with refractive index ~1.5) 35 μm to 1.4 mm.

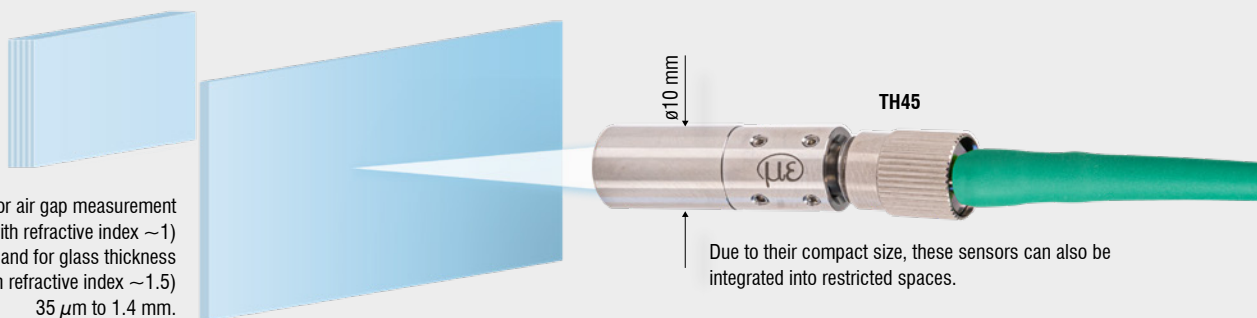

Due to their compact size, these sensors can also be integrated into restricted spaces.

Controller

Model		IMS5400-TH	IMS5400MP-TH
Resolution ^[1]		< 1 nm	
Measuring rate		continuously adjustable from 100 Hz to 6 kHz	
Linearity ^[2]		< ±100 nm ^[3] / < ±200 nm ^[4]	
Temperature stability		temperature compensated, stability < 10 ppm between +15 ... +35 °C	
Multi-peak measurement		1 layer	up to 5 layers
Light source		NIR-SLED, narrow wavelength band at approx. 840 nm; pilot laser: laser LED, wavelength 635 nm	
Laser class		Class 1 according to DIN EN 60825-1: 2015-07; Pilot laser: Class 1, power (< 0.2 mW)	
Supply voltage		24 VDC ±15 %	
Power consumption		approx. 10 W (24 V)	
Signal input		Sync in, trigger in, 2x encoders (A+, A-, B+, B-, index)	
Digital interface		Ethernet / EtherCAT / RS422 / PROFINET ^[5] / EtherNet/IP ^[5]	
Analog output		4 ... 20 mA / 0 ... 10 V (16 bit D/A converter)	
Switching output		Error1-Out, Error2-Out	
Digital output		sync out	
Connection	Optical	Pluggable fiber optic cable via E2000 socket (controller); see accessories for cable lengths; bending radius: static 30 mm, dynamic 40 mm	
	Electrical	3-pin supply terminal strip; encoder connection (15-pin, HD-sub socket, max. cable length 3 m, 30 m with external encoder supply); RS422 connection socket (9-pin, Sub-D, max. cable length 30 m); 3-pin output terminal strip (max. cable length 30 m); 11-pin I/O terminal strip (max. cable length 30 m); RJ45 socket for Ethernet (out) / EtherCAT (in/out) (max. cable length 100 m)	
Mounting		Free-standing, DIN rail mounting	
Temperature range	Storage	-20 ... +70 °C	
	Operation	+15 ... +35 °C	
Shock (DIN EN 60068-2-27)		15 g / 6 ms in XY axis, 1000 shocks each	
Vibration (DIN EN 60068-2-6)		2 g / 20 ... 500 Hz in XY axis, 10 cycles each	
Protection class (DIN EN 60529)		IP40	
Material		Aluminum housing, passive cooling	
Control and indicator elements		Multifunction button: two adjustable functions and reset to factory settings after 10 s; web interface for setup: selectable presets, freely selectable averaging, data reduction, setup management; 6 x color LEDs for intensity, range, SLED, pilot laser, status and power; pilot laser: can be switched on for sensor alignment	

^[1] All data at constant ambient temperature (24 ±2 °C). Measuring rate 0.5 kHz, moving average over 64 values, measured differentially between the front and back of a thin glass plate in the mid of the measuring range (2 sigma)

^[2] Maximum deviation from reference system over the entire measuring range, measured on front surface of ND filter

^[3] applies to the IMP TH45 and IMP MP-TH45 sensor models

^[4] applies to the IMP TH70 and IMP MP-TH70 sensor models

^[5] Optional connection via interface module (see accessories)

Sensors for thickness measurements

interferoMETER 5400-TH



Sensors for the IMS5400 controller for thickness measurements

Model		IMP TH45	IMP TH70
Working distance		45 mm ±3.5 mm	70 mm ±2.1 mm
Measuring range	Thickness ^[1]	0.035 ... 1.4 mm ^[2]	
Temperature stability		Linearity valid for the entire temperature range	
Light spot diameter ^[3]		10 μm	5 μm
Measuring angle ^[4]		±2°	±4°
Connection	Optical	Pluggable fiber optic cable via FC socket (sensor); see accessories for cable lengths; bending radius: static 30 mm, dynamic 40 mm	
Mounting		Radial clamping, mounting adapter (see accessories)	
Temperature range	Storage	-20 ... +70 °C	
	Operation	+5 ... +70 °C	
Dimensions	Diameter	Ø10	Ø20
	Length	30 mm	approx. 75 mm
Protection class (DIN EN 60529)		IP65 / IP40 (option / VAC)	IP65
Vacuum		UHV (cable and sensor)	-
Material		Stainless steel	









^[1] Values also for MP measurement

^[2] All data at constant ambient temperature (24 ±2 °C). Measuring range with n=1.5; for air gap measurement between two glass plates (n~1) the measuring range is 0.05 ... 2.1 mm. The measuring object must be within the working distance.

^[3] With a working distance of 45 mm (TH-45) or 70 mm (TH-70)

^[4] Maximum sensor tilt angle that produces a usable signal on an approx. 0.6 mm thick BK7 optical flat in the mid of the measuring range. The accuracy decreases when approaching the limit values.

High precision inline wafer thickness measurement interferoMETER 5420

-  Nanometer-precise thickness measurement from 0.05 to 1.05 mm (SI wafers)
-  Undoped, doped and highly doped wafers
-  Multi-peak: up to 5 layers in one measurement
-  High resolution 1 nm
-  Measuring rate up to 6 kHz for high speed measurements
-  Ethernet / EtherCAT / RS422 / PROFINET / EtherNet/IP
-  Easy configuration via web interface
-  Flexible industrial integration



Stable wafer thickness measurement in inline processes

The IMS5420-TH absolute interferometer opens up new perspectives in the industrial thickness measurement of monocrystalline silicon wafers and silicon carbide wafers and comparable materials that are transparent for a wavelength range of 1,100 nm. Due to its broadband superluminescent diode (SLED), the IMS5420-TH can be used for undoped, doped and highly doped SI wafers. In wafer thickness measurements, the IMS5420-TH impresses with an excellent price/performance ratio.

Due to the optical transparency of silicon wafers, interferometers can precisely detect the thickness in the wavelength range of 1,100 nm. This makes it possible to measure the thickness of wafers up to 1.05 mm. The measurable thickness of air gaps is even up to 4 mm.

The absolute interferometer achieves signal stability in the submicrometer range. The thickness can be measured from a distance of 24 mm which makes this measuring system ideally suited for inline measurements.

The measuring system is available as a thickness measuring system or as a multi-peak thickness measuring system. The multi-peak system measures thicknesses of up to five layers, e.g., wafer thickness, air gap, films and coatings.

The IMS5420/IP67 controller with IP67 and stainless steel housing is available for thickness measurements in challenging environmental conditions such as wafer lapping.

Doping	Element	Specific resistance
P-	Boron	1-150 Ω·cm
N-	Phosphorus	1-200 Ω·cm
P+	Boron	0.01-0.02 Ω·cm
P++	Boron	0.005-0.01 Ω·cm

20 μm light spot



With multi-layer thickness measurements of silicon wafers, up to 5 layers from 50 to 1050 μm can be detected.



Due to their compact size, these sensors can also be integrated into restricted spaces.

The measuring range for air gap measurement (with refractive index ~1) is 0.2 to 4.0 mm and for wafer thickness measurement (with refractive index ~3.82) 50 μm to 1.05 mm.

Controller

Model	IMS5420-TH	IMS5420MP-TH	IMS5420IP67-TH	IMS5420IP67MP-TH
Resolution ^[1]	< 1 nm			
Measuring rate	continuously adjustable from 100 Hz to 6 kHz			
Linearity ^[2]	< ±100 nm	< ±100 nm with one layer; < ±200 nm for other layers	< ±100 nm	< ±100 nm with one layer; < ±200 nm for other layers
Temperature stability	temperature compensated, stability < ±50 ppm between +10 ... +50 °C			
Multi-peak measurement	1 layer	up to 5 layers	1 layer	up to 5 layers
Light source	NIR-SLED, narrow wavelength band at approx. 1100 nm; pilot laser: laser LED, wavelength 635 nm		NIR-SLED, narrow wavelength band at approx. 1100 nm	
Laser class	Class 1 according to DIN EN 60825-1: 2022-07; Pilot laser: Class 1, power (< 0.2 mW)		Class 1 in accordance with DIN EN 60825-1: 2022-07	
Supply voltage	24 VDC ±15 %			
Power consumption	approx. 10 W (24 V)			
Signal input	Sync in, trigger in, 2x encoders (A+, A-, B+, B-, index)		-	
Digital interface	Ethernet / EtherCAT / RS422 / PROFINET ^[3] / EtherNet/IP ^[3]		Ethernet / RS422 / PROFINET ^[3] / EtherNet/IP ^[3]	
Analog output	4 ... 20 mA / 0 ... 10 V (16 bit D/A converter)		-	
Switching output	Error1-Out, Error2-Out		-	
Digital output	sync out		-	
Connection	Optical	Pluggable fiber optic cable via E2000 socket (controller); see accessories for cable lengths; bending radius: static 30 mm, dynamic 40 mm		Pluggable optical fiber via IP9 SC socket, standard lengths 1 m and 2 m, other cable lengths on request; bending radius: static 45 mm, dynamic 60 mm
	Electrical	3-pin supply terminal strip; encoder connection (15-pin, HD-sub socket, max. cable length 3 m, 30 m with external encoder supply); RS422 connection socket (9-pin, Sub-D, max. cable length 30 m); 3-pin output terminal strip (max. cable length 30 m); 11-pin I/O terminal strip (max. cable length 30 m); RJ45 socket for Ethernet (out) / EtherCAT (in/out) (max. cable length 100 m)		4-pin M12 connector for supply; RS422 connector (5-pin, M12, max. cable length 30 m); RJ45 socket for Ethernet (out) / EtherCAT (in/out) (max. cable length 100 m)
Mounting	Free-standing, DIN rail mounting		Through bores	
Temperature range	Storage	-20 ... +70 °C		
	Operation	+10 ... +50 °C		
Shock (DIN EN 60068-2-27)	15 g / 6 ms in XY axis, 1000 shocks each			
Vibration (DIN EN 60068-2-6)	2 g / 20 ... 500 Hz in XY axis, 10 cycles each			
Protection class (DIN EN 60529)	IP40		IP67	
Material	Aluminum housing, passive cooling		Stainless steel housing	
Control and indicator elements	Multifunction button: two adjustable functions and reset to factory settings after 10 s; web interface for setup: selectable presets, freely selectable averaging, data reduction, setup management; 6 x color LEDs for intensity, range, SLED, pilot laser, status and power; pilot laser: can be switched on for sensor alignment		Web interface for setup: selectable presets, freely selectable averaging, data reduction, setup management; power LED	

^[1] All data at constant ambient temperature (22 ±3 °C). Measuring rate 0.5 kHz, moving average over 64 values, measured on an approx. 0.8 mm thick silicon (2 sigma) polished on both sides

^[2] Maximum thickness deviation when measuring on an approx. 0.8 mm thick silicon polished on both sides (n=3.8) when passing through the measuring range

^[3] Optional connection via interface module (see accessories)

Sensors for wafer thickness measurements

interferoMETER 5420



Sensors for the IMS5420 controller for wafer thickness measurement

Model		IMP TH24
Working distance		24 mm ±3.0 mm
Measuring range (Thickness)	Silicon	0.05 ... 1.05 mm ^[1]
	Air	0.2 ... 4 mm ^[2]
Temperature stability		temperature compensated, stability < ±50 ppm between +10 ... +50 °C
Light spot diameter ^[3]		20 μm
Measuring angle ^[4]		±1.5°
Connection	Optical	Pluggable fiber optic cable via FC socket (sensor); see accessories for cable lengths; bending radius: static 30 mm, dynamic 40 mm
Mounting		Radial clamping, mounting adapter (see accessories)
Temperature range	Storage	-20 ... +70 °C
	Operation	+10 ... +50 °C (front side)
Dimensions	Diameter	Ø10
	Length	25 mm
Protection class (DIN EN 60529)		IP65 (optional IP67) ^[5]
Vacuum		on request UHV (cable and sensor)
Material		Stainless steel

^[1] All data at constant ambient temperature (22 ±3 °C). Measuring range at n=3.82 (silicon); measurable thickness depends on doping (see table)

^[2] For air gap measurement between two glass plates (n~1) the measuring range is 0.2 ... 4 mm. The measuring object must be within the working distance.

^[3] With a working distance of 24 mm (TH-24) or 17.5 mm (204)

^[4] Maximum sensor tilt angle that produces a usable signal on an approx. 0.8 mm thick silicon in the mid of the measuring range. The accuracy decreases when approaching the limit values.

^[5] Other protection classes on request

Dimensions

IMS5420 controller

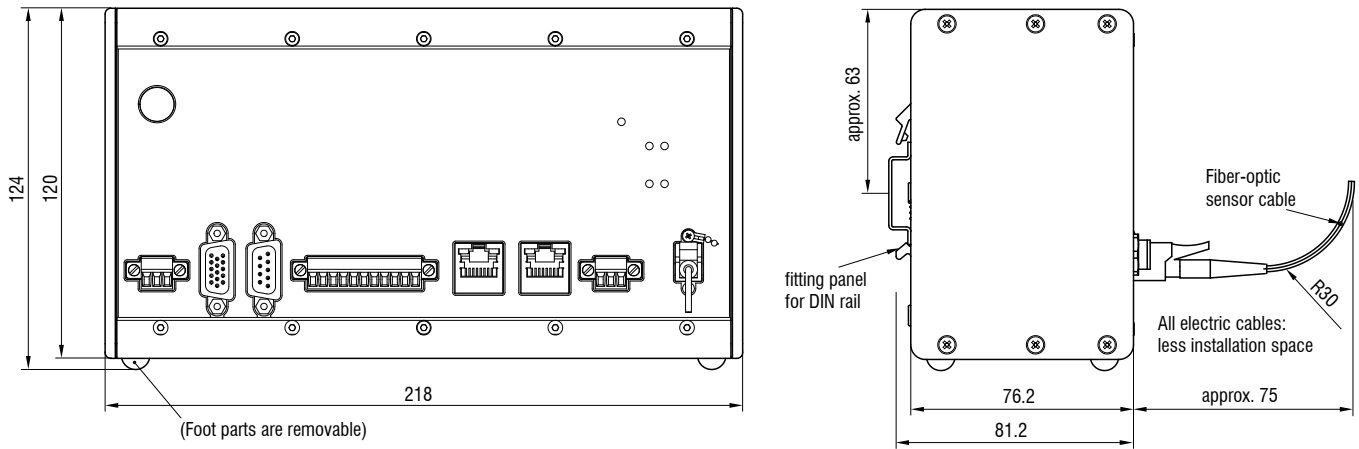

IMS5420/IP67-TH24 Measuring system with controller housing made of stainless steel and protection class IP67

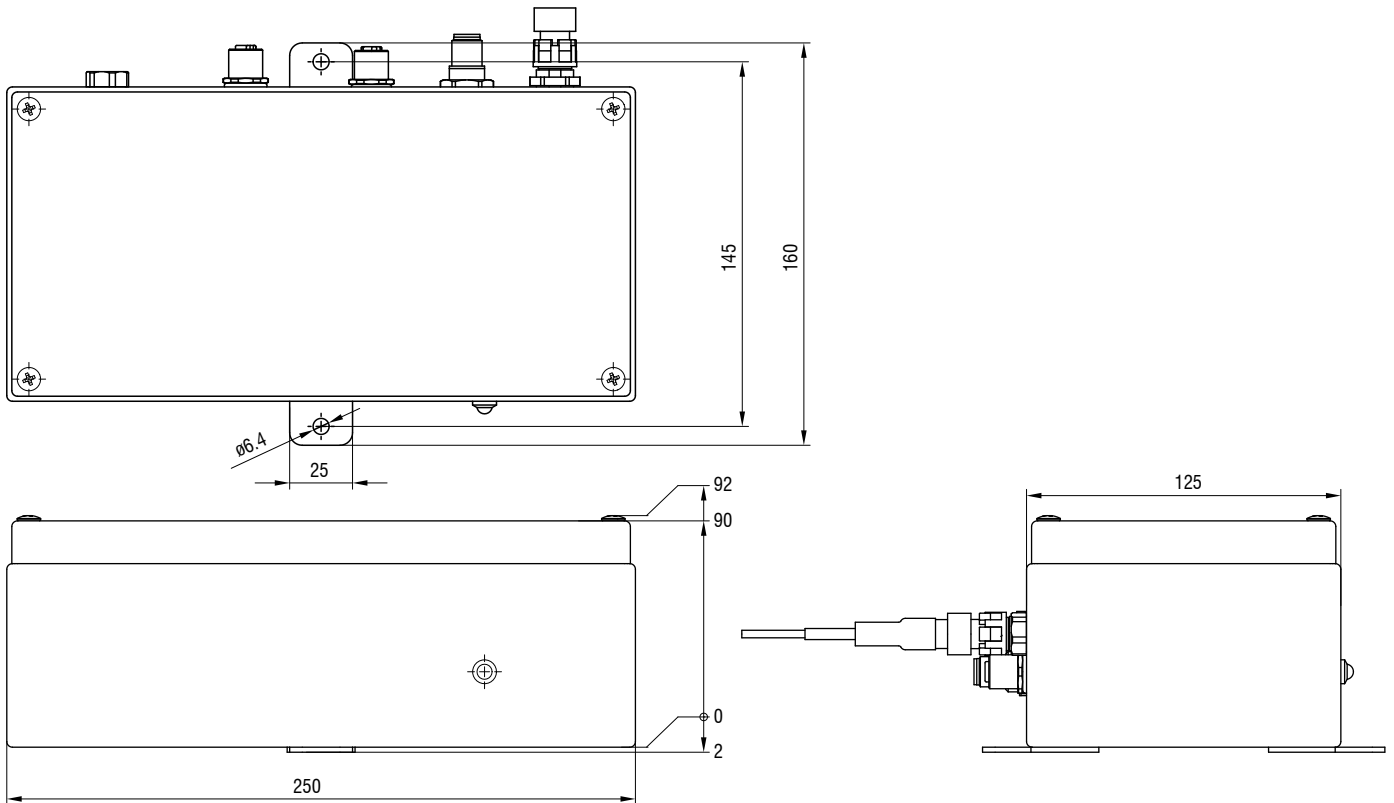

Thickness sensor IMP TH24

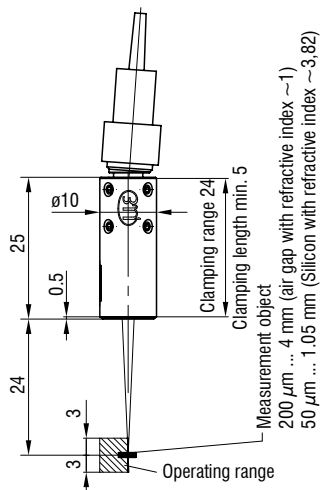

Connection possibilities interferoMETER

Connection options for the IMS5400 and IMS5600 controllers

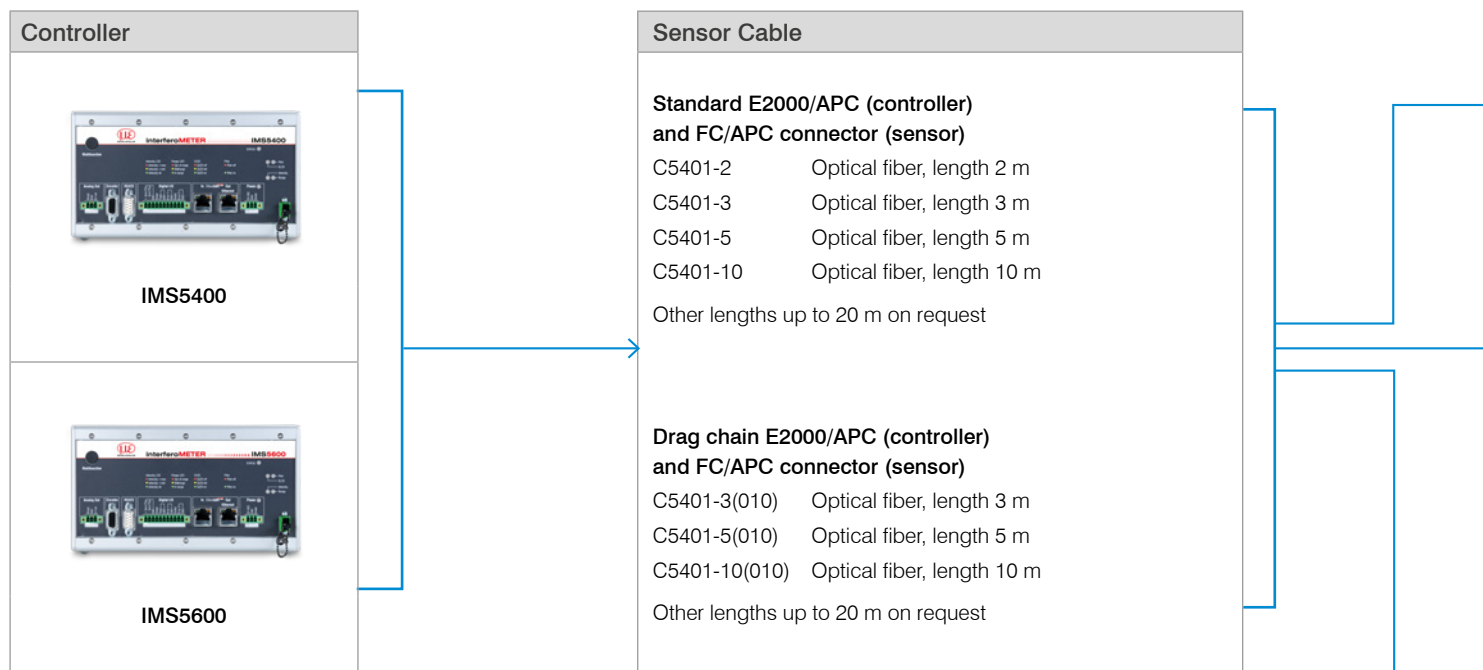

Connection options for the IMS5420 controller

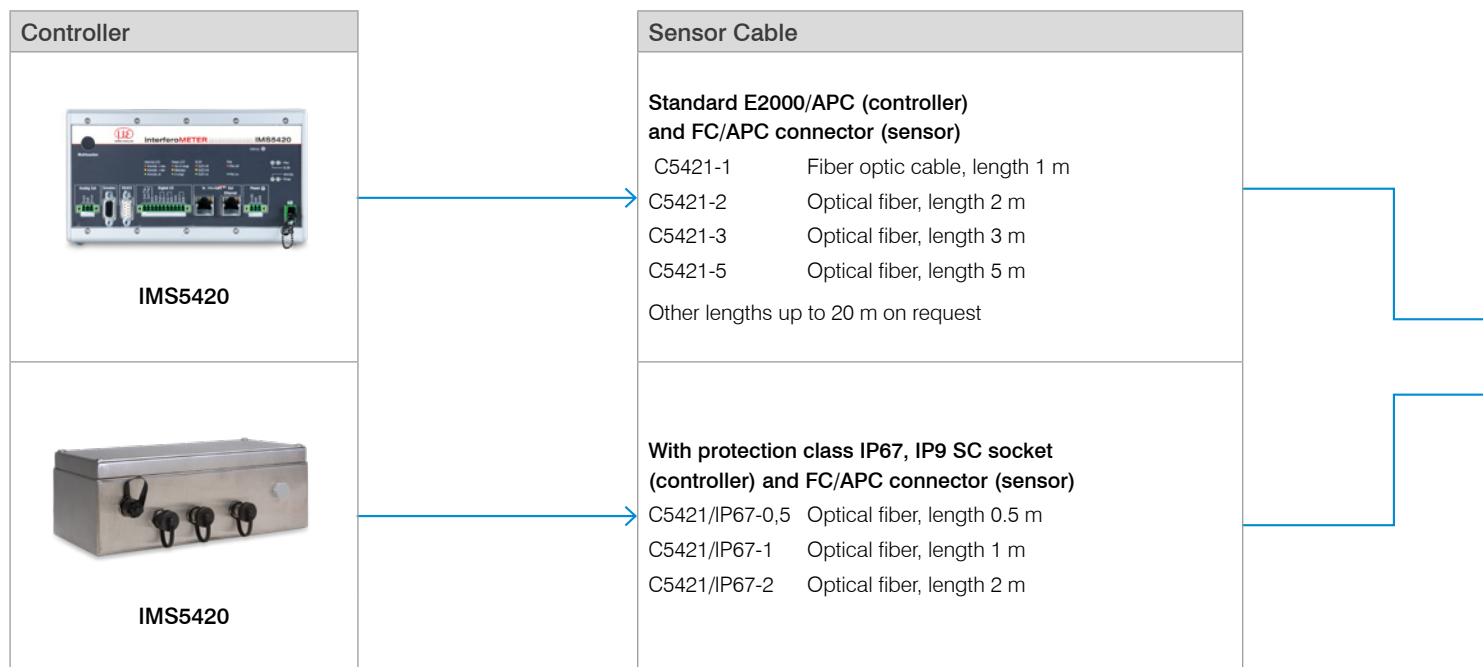

Connector

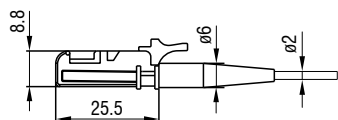

E2000/APC Standard connector

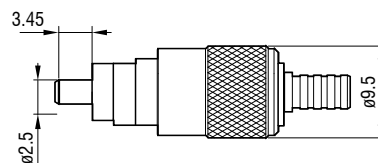
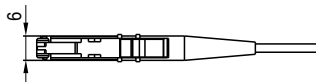

FC/APC Standard connector

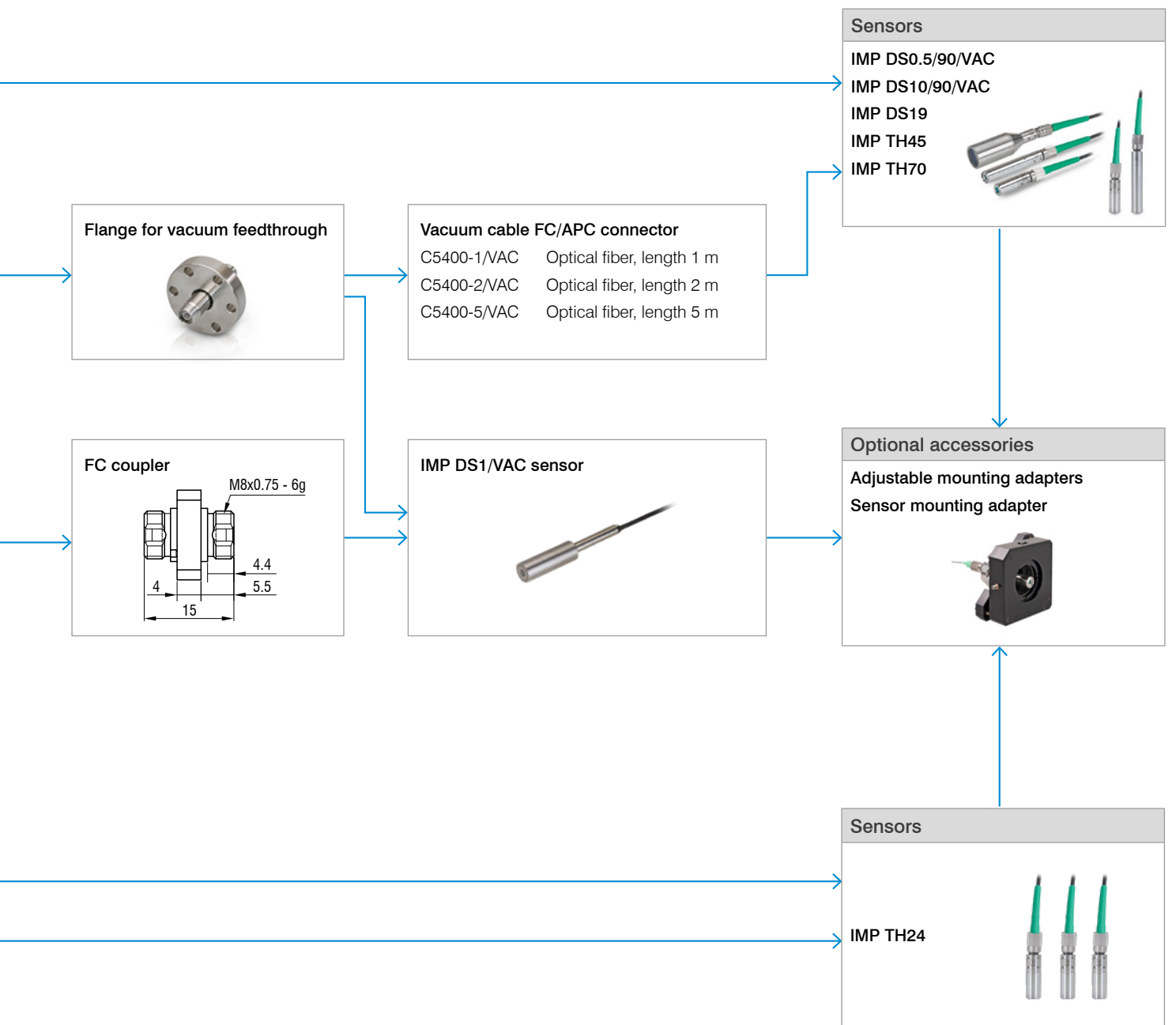

Article designations

DS IMS5xxx-DSxx
distance measuring system
(e.g. IMS5600MP-DS19)

IMS5xxx	-DSxx
Controller model	Sensor model
IMS5400	DS1/VAC
IMS5400MP	DS19
IMS5600	DS19/VAC
IMS5600MP	DS0.5/90/VAC DS10/90/VAC

TH IMS5xxx-THxx
thickness measuring system
(e.g. IMS5400-TH45/VAC)

IMS5xxx	-THxx
Controller model	Sensor model
IMS5400	TH45
IMS5400MP	TH45/VAC TH70

TH IMS5420xx-THxx
wafer thickness measuring system
(e.g. IMS5420-TH24)

IMS5xxx	-THxx
Controller model	Sensor model
IMS5420	TH24
IMS5420MP	TH24(204)
IMS5420IP67	
IMS5420IP67MP	

Optional accessories

interferoMETER

Flange for vacuum feedthrough

C5405/VAC/1/CF16 CF flange

C5405/VAC/1/KF16 KF flange

Mounting adapter

MA5400- 10 Mounting adapter for IMP-DS19/ -TH45

MA5400- 20 Mounting adapter for IMP-TH70

MA2402-4 Mounting adapter for IMP-DS1

Other accessories

SC2471-x/IF2008 IMC5400/5600 connector cable+ IF2008/PCIE, length 3 m / 10 m

SC2471-x/RS422/OE IMC5400/5600 interface cable + IF2001/USB, length 3 m / 10 m

IF2001/USB RS422/USB converter

IF2008/PCIE Interface card

IF2035/PNET Interface module for PROFINET integration

IF2035-EIP Interface module for EtherNet/IP with DIN rail housing

PS2020 Power supply 24V / 2.5A

EC2471-3/OE Encoder cable, 3 m



C5405/VAC/1/CF16
C5405/VAC/1/KF16

Sensor mounting adapter

MA5400-10

Sensor mounting adapter for all interferoMETER sensors:

(exception IMP-DS1, IMP-TH70)

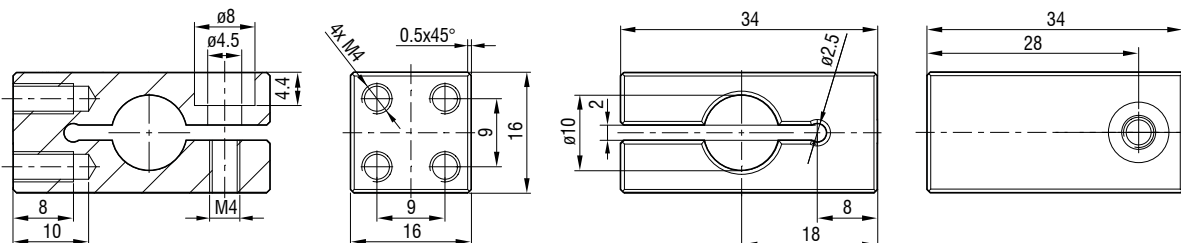

MA5400-20

Sensor mounting adapter for IMP-TH70 sensors:

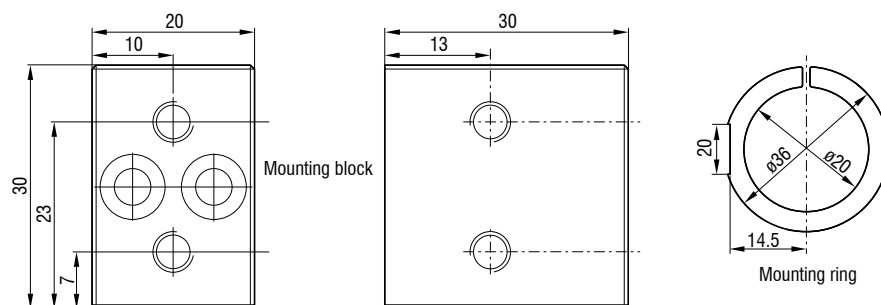

MA2402-4

Sensor mounting adapter for IMP-DS1 sensors

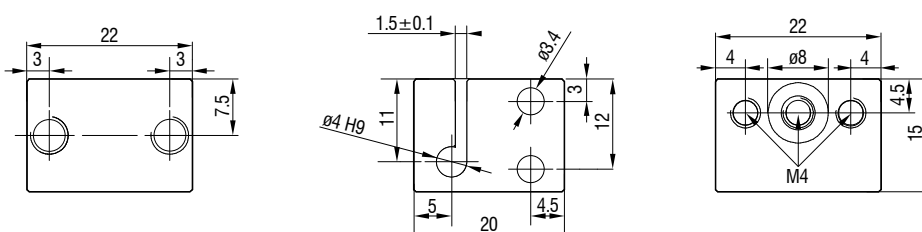

Adjustable mounting adapter

The adjustable JMA mounting adapter simplifies the alignment and fine adjustment of interferometric sensors. The sensors and adapters can be integrated into the machine and aligned directly on site. This corrects, e.g., minor deviations caused by mounting and compensates for tilted measuring objects. With two-sided thickness measurements, the mounting adapter supports the fine alignment of the two measuring points.

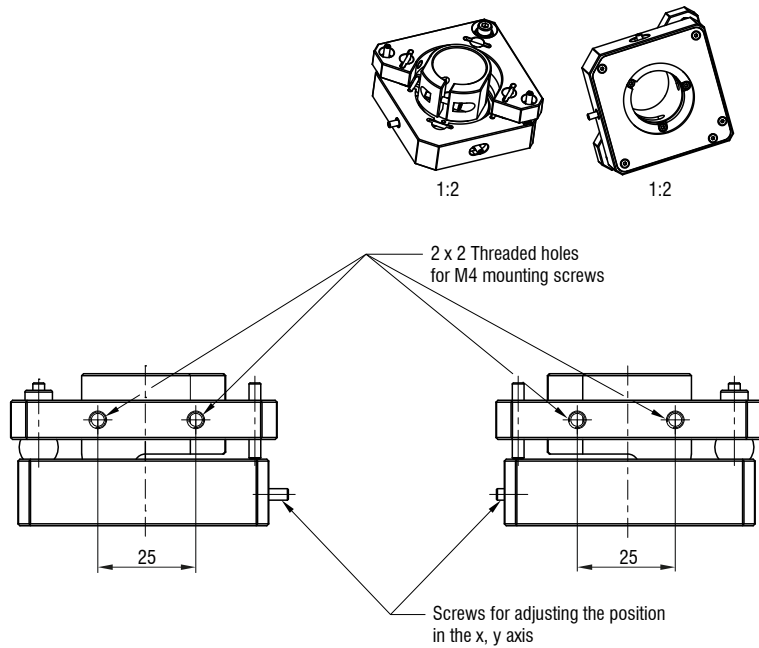
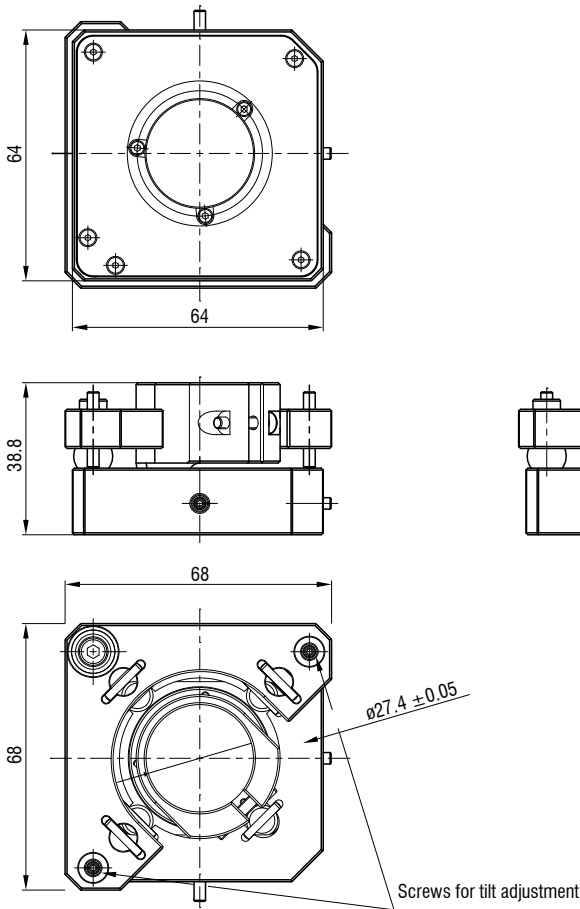

Scope of supply

- Adjustable mounting adapter
- Sensor holder for sensors $\varnothing 10$ and $\varnothing 20$ mm
- Screwdriver for positioning
- Assembly instructions

Sensor holder

Sensor holder for JMA-10

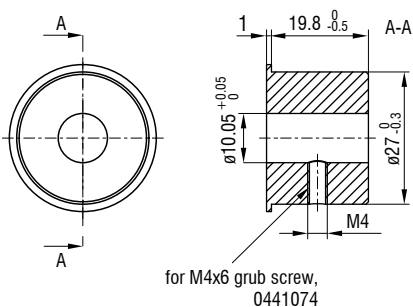

Sensor holder for JMA-20

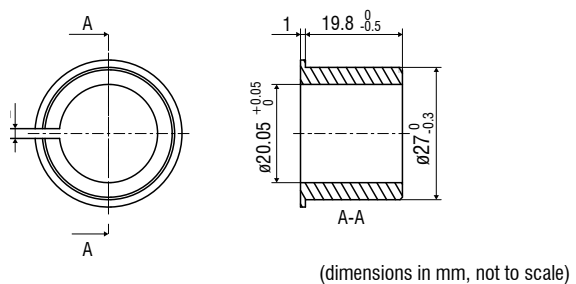

Sensors and Systems from Micro-Epsilon

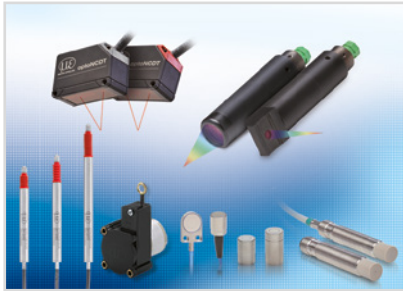

Sensors and systems for displacement, position and dimension



Sensors and measurement devices for non-contact temperature measurement



Measuring and inspection systems for quality assurance

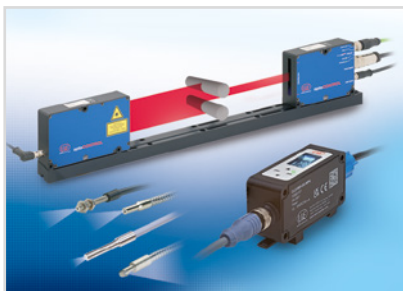

Optical micrometers, fiber optics, measuring and test amplifiers



Color recognition sensors, LED Analyzers and inline color spectrometers



3D measurement technology for dimensional testing and surface inspection